

- English • Read Safety and Reference.
- Русский • Прочтите **Руководство по технике безопасности**.
- Українська • Прочитайте **"Правила безпеки та довідкова інформація"**.
- Қазақша • **Қауіпсіздік нұсқаулығын** оқыңыз.
- O'zbekcha • Xavfsizlik bo'yicha ko'rsatmalar va havolalar'ni o'qib chiqing.
- Монгол • Аюулгүй ажиллагааны зааварчилгааг уншина уу.

⊕ : Depending on model / В зависимости от модели / Залежно від моделі / Үлгіге байланысты / Rusumiga qarab / Загвараас хамаарна

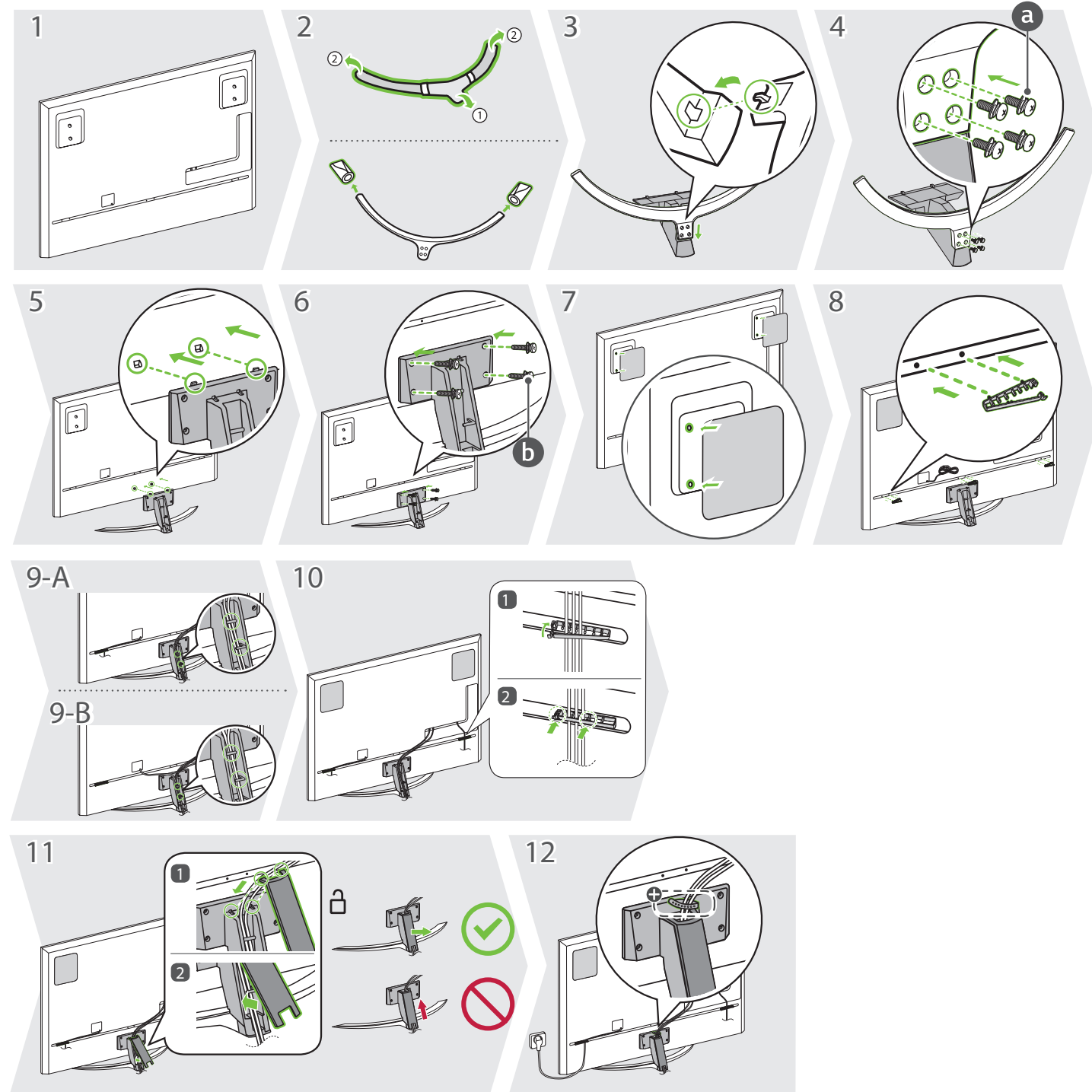

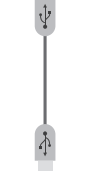
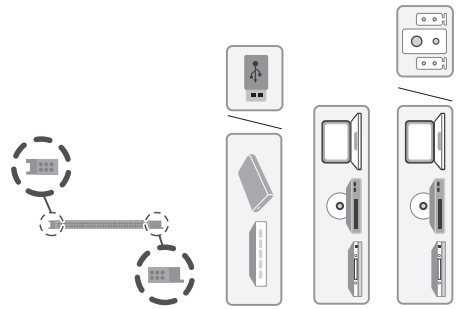
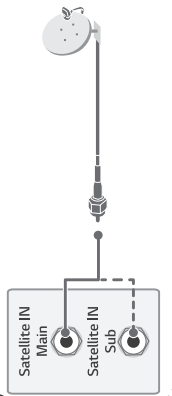
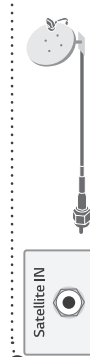

⊕ : Depending on model / В зависимости от модели / Залежно від моделі / Улігіе байланысты / Русуміга қараб / Загвараас хаммарна

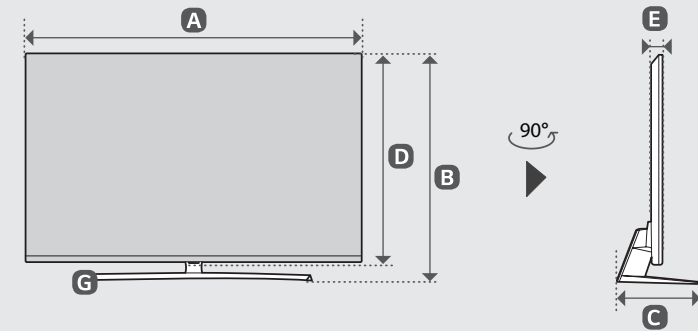
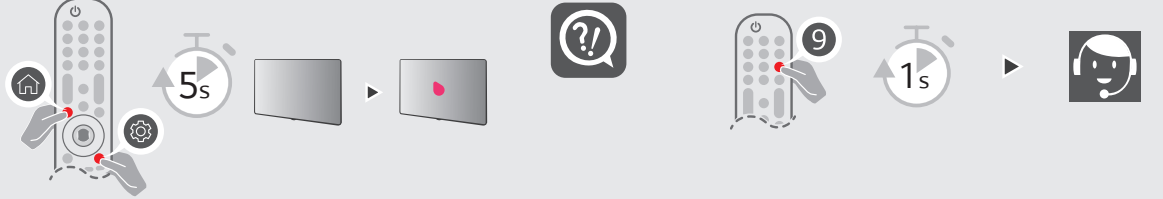
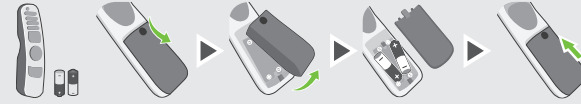

	A	B	C	D	E	F	F-G
	(mm)				(kg)		
86QNED993PB 86QNED996PB 86QNED999PB	1917	1175	452	1098	29.9	59.2	55.4
Требования к электропитанию Вимоги до електроживлення Електртітуыны шарттары				AC 100-240 V ~ 50 / 60 Hz			